

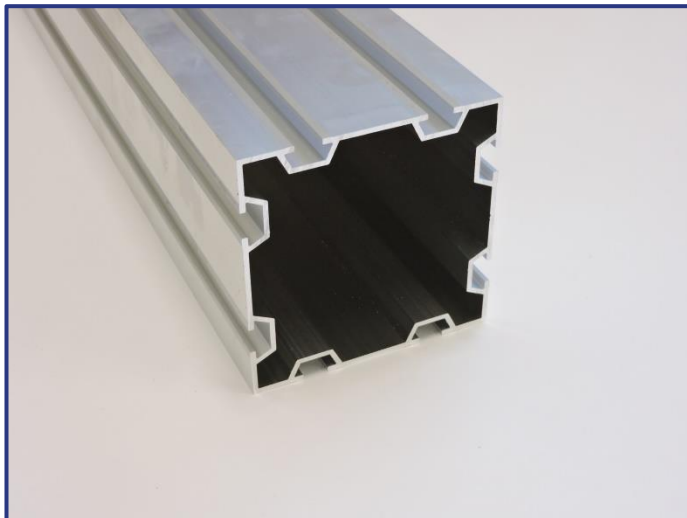

## KLOPPROFIELEN CRYSTAL ISERMATIC



### P100

10x10cm; 8 geulen; 3kg/lm  
volumes  
geveltoepassing  
zelfdragende constructies

Uitvoering: alu brut  
Lengte: 4m en 5m  
Accessoires: EQS100                      PIED S100  
                  EQARTS100                  POTEN S100  
                  EQASS S100                  VIS S100  
                  MANCH S100

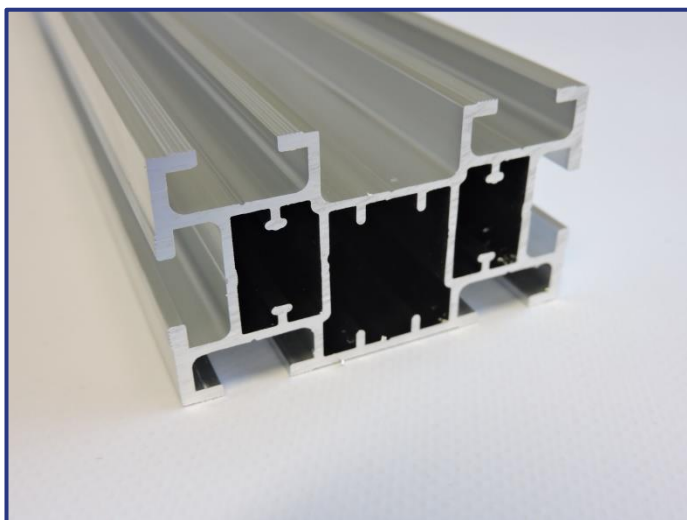

### KT+

64x36,5mm; 6 geulen; 1,4kg/lm  
geveltoepassing  
zelfdragende constructies

Uitvoering: alu brut of wit gelakt  
Lengte: 3m50 en 5m  
Accessoires: CLM                          EQABS  
                  EQKT+MUR                      TU 10CM  
                  EQART KT+  
                  EQKT

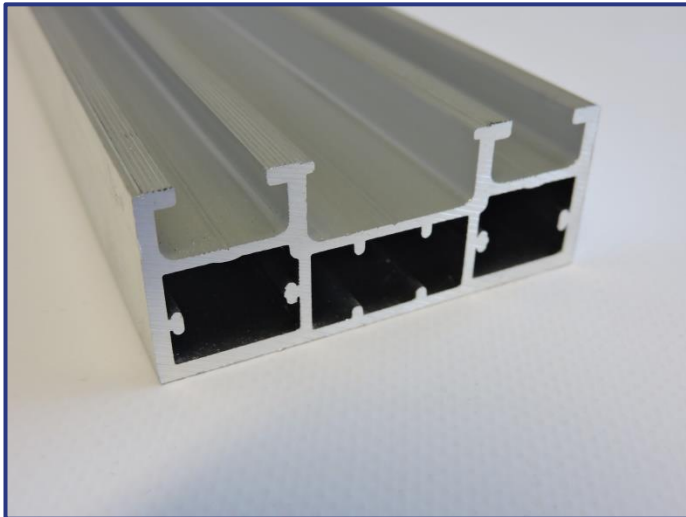

## KT

660x24mm; 2 geulen; 1kg/lm  
geveltoepassing

Uitvoering: alu brut  
Lengte: 3m50 en 5m  
Accessoires: EQABS 2  
TU 12

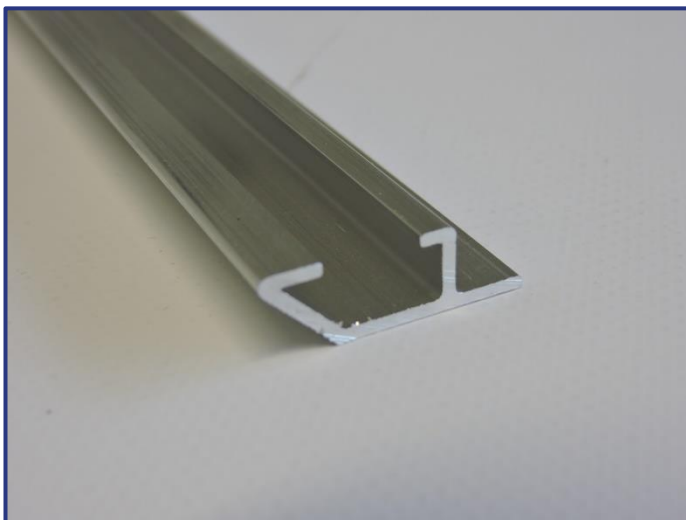

## KTA

27x9mm; 1 geul; 0,168kg/lm  
binnengebruik, buitengebruik beperkt  
vlakke muur

Uitvoering: alu brut  
Lengte: 3m50  
Accessoires: geen

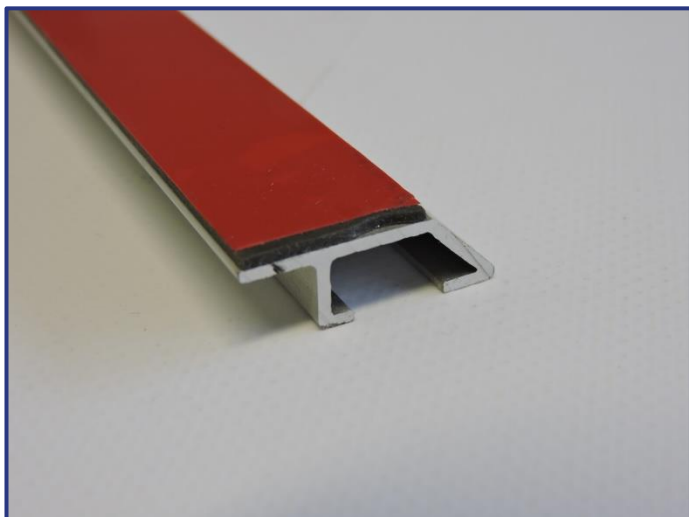

## KTA ADH

27x9mm; 1 geul; 0,168kg/lm  
binnengebruik, buitengebruik beperkt  
voorzien van dubbelzijdige tape 3M  
voor plaatsen waar niet geboord mag worden

Uitvoering: alu brut  
Lengte: 3m50  
Accessoires: geen

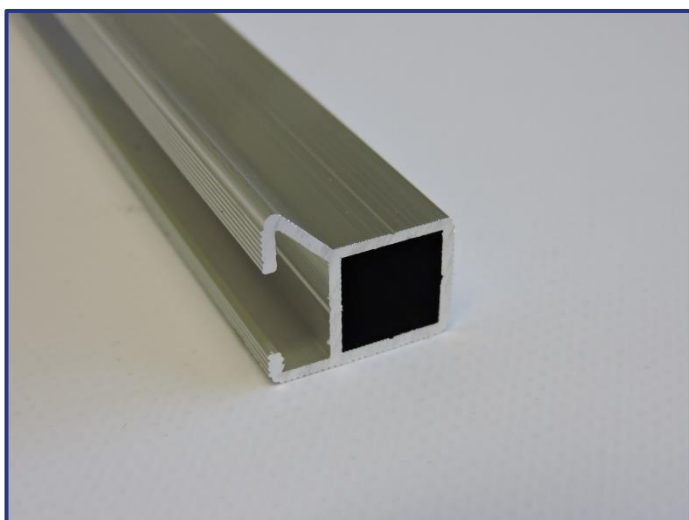

## KTN

20x22mm; 1 geul; 0,228kg/lm  
binnengebruik, buitengebruik beperkt  
vlakke muur

Uitvoering: alu brut  
Lengte: 3m50  
Accessoires: EQABS  
TU 10CM

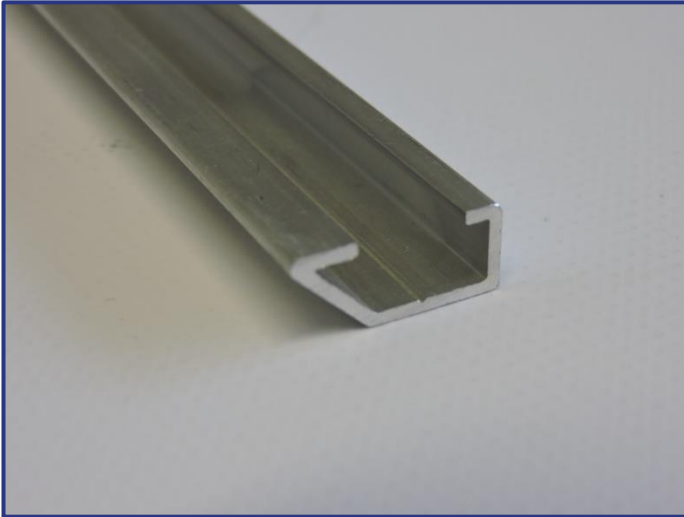

**C**

20x8mm; 1 geul; 0,117kg/lm  
binnengebruik  
ook in combinatie met profiel KTN

Uitvoering: alu brut  
Lengte: 3m50  
Accessoires: geen

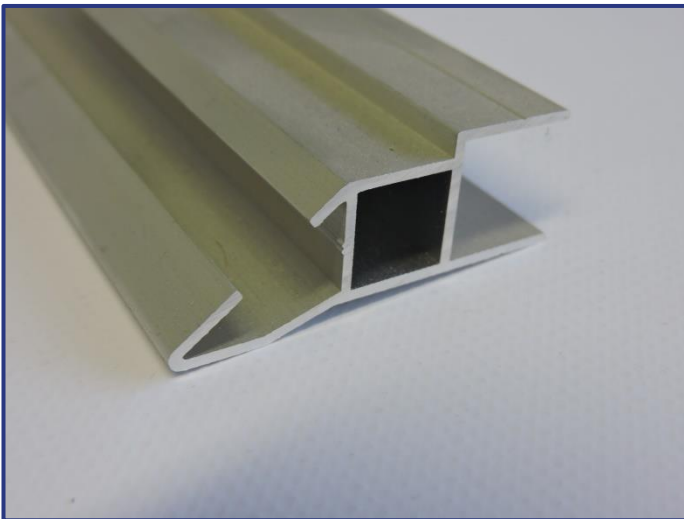

**KL+**

49x20mm; 1 geul; 0,389kg/lm  
zelfdragende kaders klein formaat  
spanlat aan achterkant kader

Uitvoering: alu brut  
Lengte: 3m50 en 7m  
Accessoires: EQABS

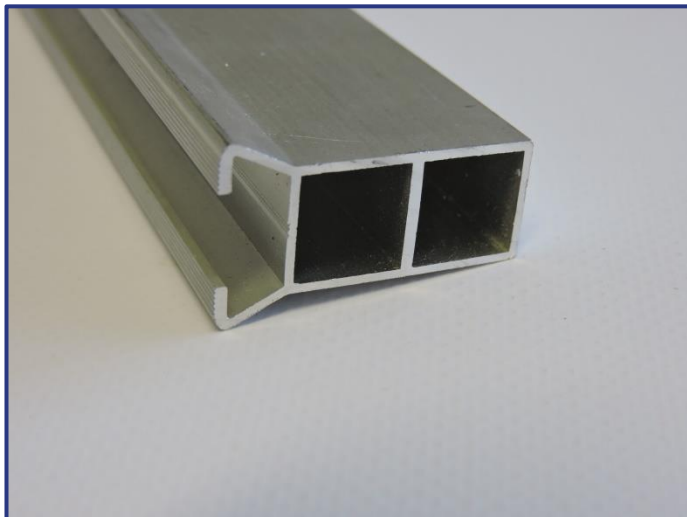

## KP

35x20mm; 1 geul; 0,317kg/lm  
zelfdragende kaders klein formaat  
spanlat aan zijkant kader

Uitvoering: alu brut of wit gelakt  
Lengte: 3m50 en 7m  
Accessoires: EQABS                      FIX 30  
                  C15                              PFIX  
                  FIX 15  
                  SX 30

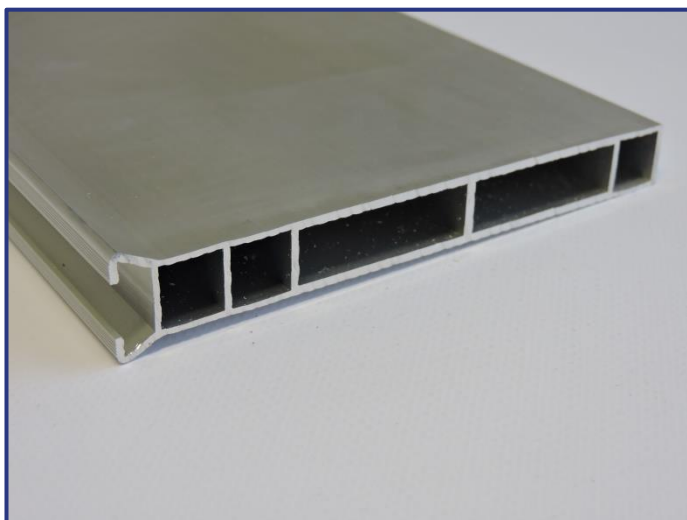

## KPP

125x20mm; 1 geul; 1,169kg/lm  
zelfdragende kaders groot formaat  
spanlat aan zijkant kader

Uitvoering: alu brut of wit gelakt  
Lengte: 3m50 en 7m  
Accessoires: EABQS                      FIX 50  
                  SX 30                                      PFIX  
                  FIX 30  
                  SX 50

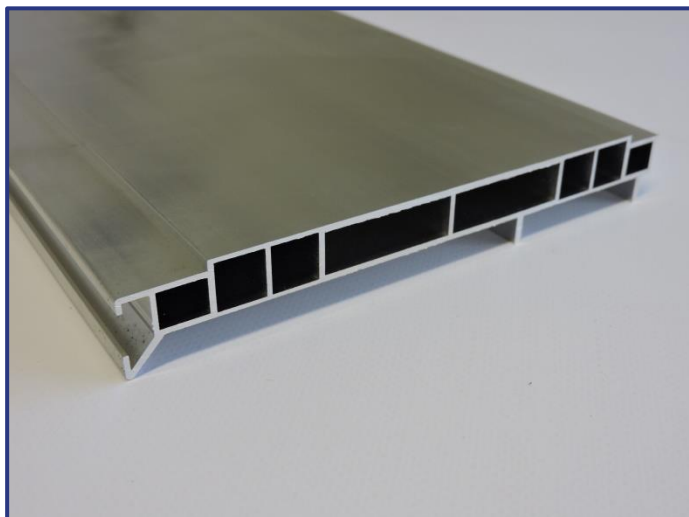

## KPPS

160x22mm; 1 geul; 1,6kg/lm  
lichtbakken  
spanlat aan voorzijde kader

Uitvoering: alu brut of wit gelakt

Lengte: 3m50 en 7m

Accessoires:	EQABS	FIX 50	EQERA
	SX 30	EQ120	CAV
	FIX 30	EQ	L20
	SX 50	EQRAID	

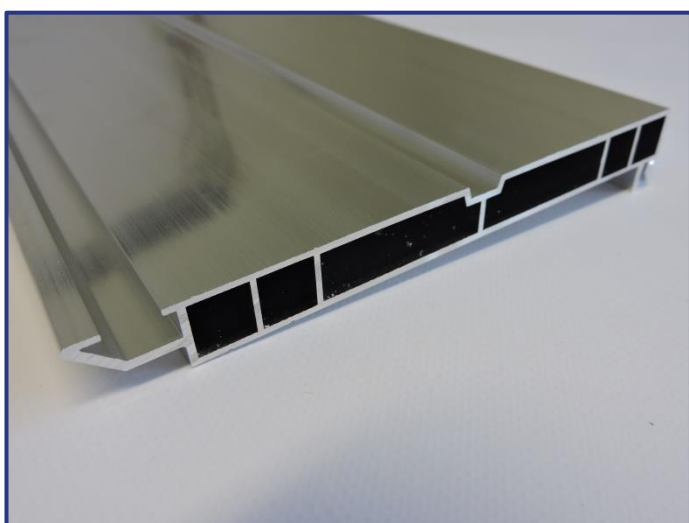

## KPPS SF

160x22mm; 1 geul; 1,6kg/lm  
lichtbakken  
spanlat aan zijkant kader

Uitvoering: alu brut of wit gelakt

Lengte: 3m50 en 7m

Accessoires:	EQABS	FIX 50	EQERA
	SX 30	EQ120	CAV
	FIX 30	EQ	L20
	SX 50	EQRAID	

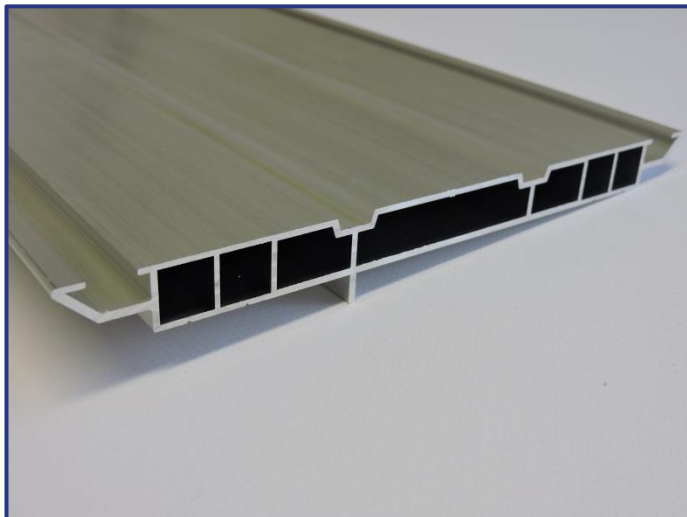

## KPPS DF

190x22mm; 2 geulen; 1,8kg/lm  
dubbelzijdige lichtbakken  
spanlat aan zijkant kader

Uitvoering: alu brut of wit gelakt

Lengte: 3m50 en 7m

Accessoires:	EQABS	FIX 50	EQERA
	SX 30	EQ120	CAV
	FIX 30	EQ	L20
	SX 50	EQRAID	

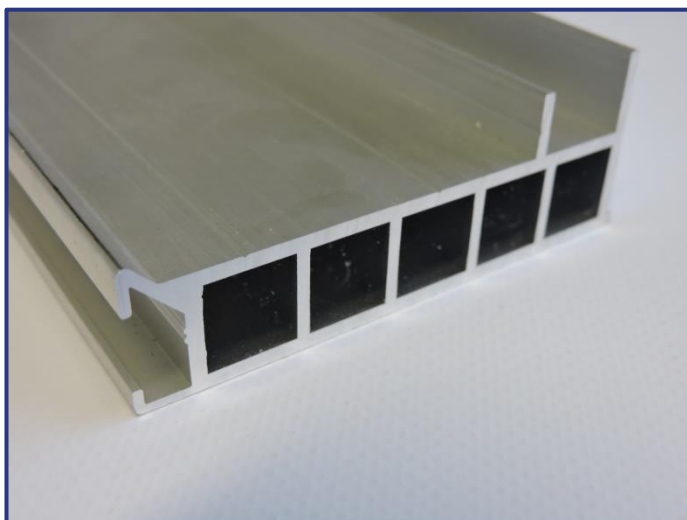

## KPPS SLIM

80x29mm; 1 geul; 1,34kg/lm  
lichtbakken  
spanlat aan voorzijde kader

Uitvoering: alu brut of wit gelakt

Lengte: 3m50 en 7m

Accessoires:	EQABS 2	FIX 50
	SX 30	EQERA 2
	FIX 30	EQ120
	SX 50	



## ACCESSOIRES

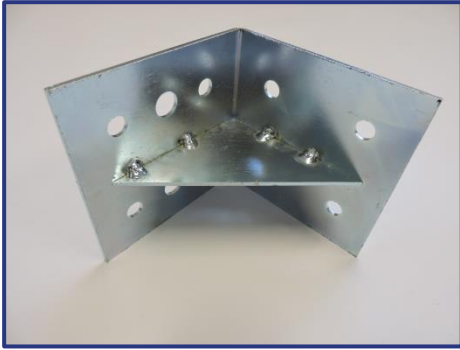

**EQS100**

verstekhoek 95x95mm

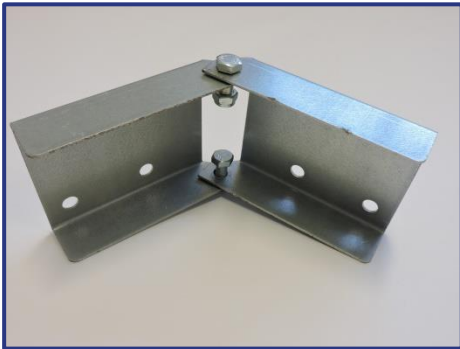

**EQARTS100**

scharnierstuk



**EQASS S100**

vlakke verstekhoek 90°



**MANCH S100**

verbindingsstuk



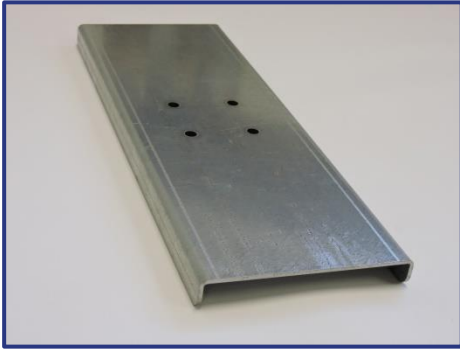

**PIED S100**

voet

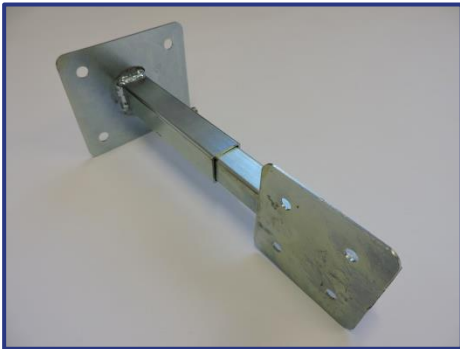

**POTEN S100**

afstandshouder



**VIS S100**

schroefplaatje



**CLM**

bevestigingsclamp

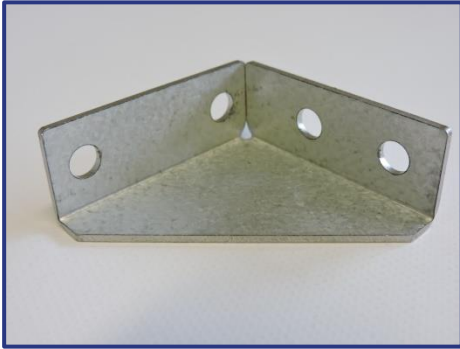

**EQKT+MUR**

verstekhoek voor muurbevestiging en hoekversteving

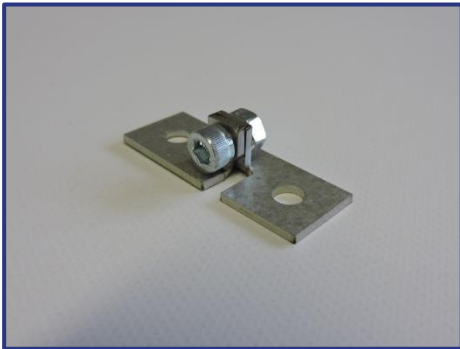

**EQART KT+**

scharnierstuk

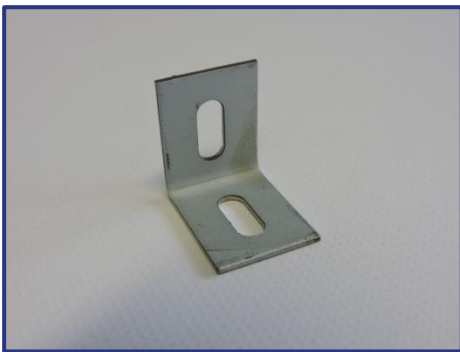

**EQKT**

verstekhoek 90°



**EQABS**

plastic verstekhoek binnenin profiel



**EQABS 2**

plastic verstekhoek binnenin profiel

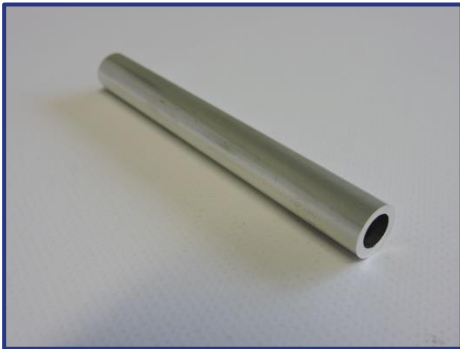

**TU 10CM**

verlengstaafje

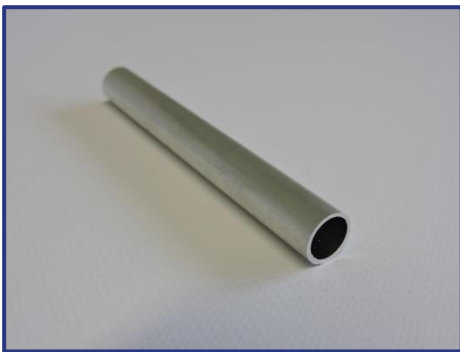

**TU 12**

verlengstaafje

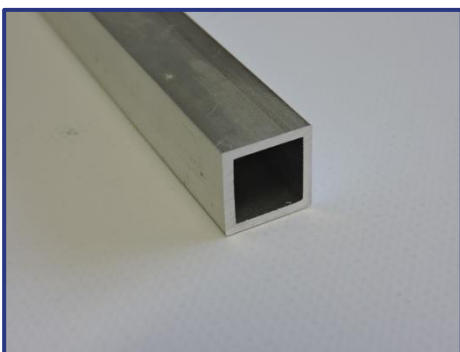

**C15**

versteving 15x15x1,5mm

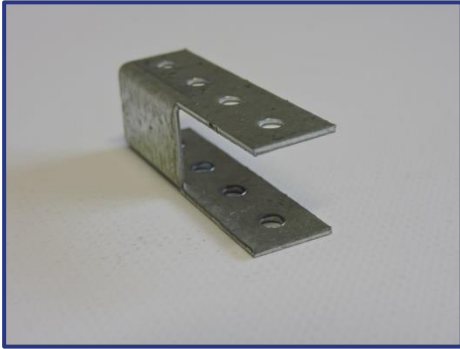

**FIX 15**

bevestiging versteving C15 op profiel

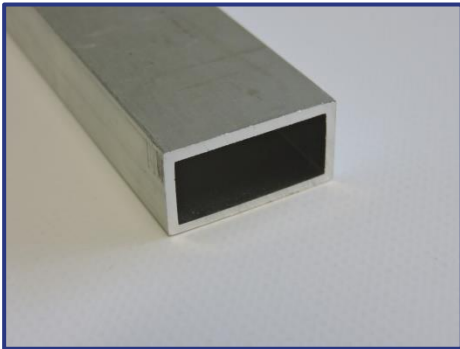

**SX 30**

versteving 30x15x1,5mm



**FIX 30**

bevestiging versteving SX 30 op profiel

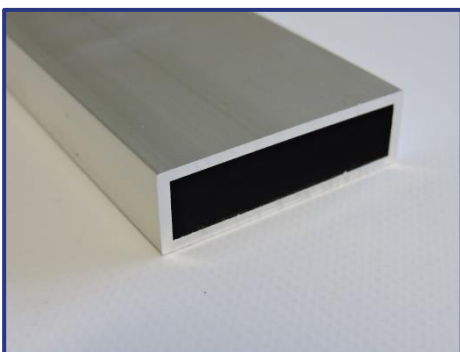

**SX 50**

versteving 50x15x2mm

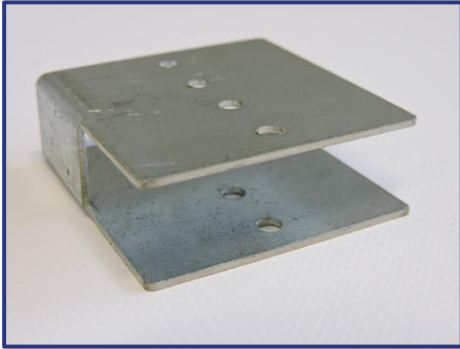

**FIX 50**

bevestiging versterking SX 50 op profiel

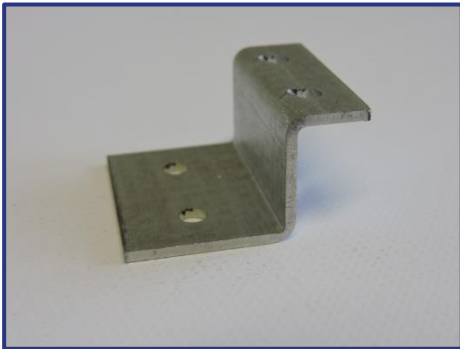

**PFIX**

ophangplaatje



**EQ120**

verstekhoek 120x120mm

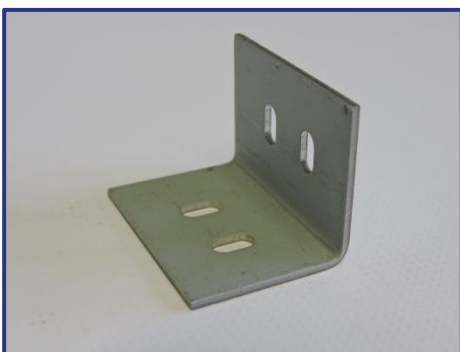

**EQ**

verstekhoek

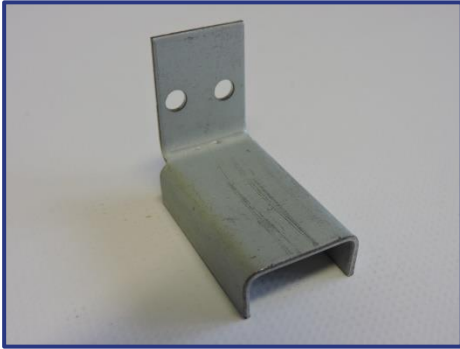

**EQRAID**

verbinding profiel en versterking SX 30



**EQERA**

verstekhoek tussen profiel en versterking



**EQERA 2**

verstekhoek tussen profiel en versterking



**CAV**

verbinding SX 50

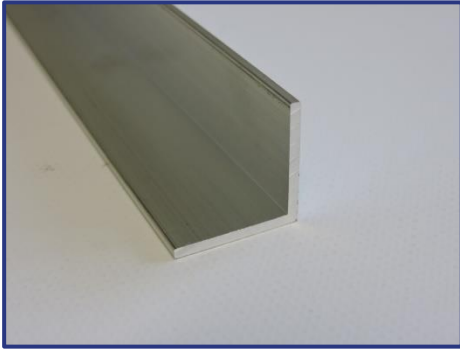

**L20**

L-profiel alu brut 25x25mm; lengte 3m

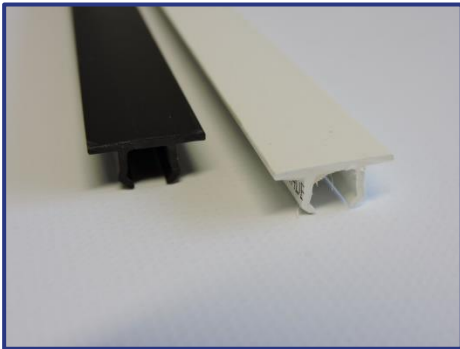

**JONC JN**

binnengebruik in wit of zwart

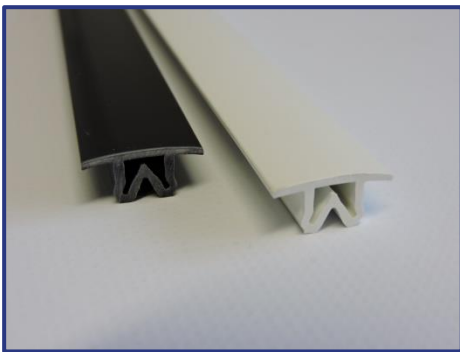

**JONC JR**

buitengebruik in wit of zwart



**JONC FIN**

binnengebruik voor dunne doeken/textiel



**MAILLET**

terugslagvrije hamer



**PINCE JONC**

kniptang spanlatten